

P/N: FAT74050

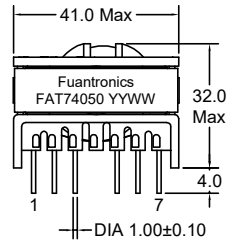

Outline Dimensions (Unit:mm)



Orthographic view

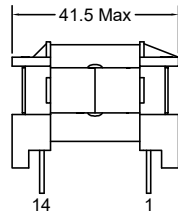

Side view

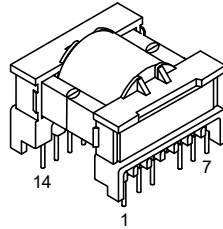

Stereogram

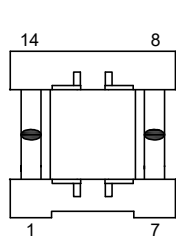

Top view

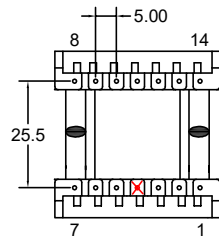

Bottom view

REMARK:

1. Remove Pin4 .
2. Product vacuum impregnation.
3. Fixing of magnetic core with black glue.

Electrical Schematic

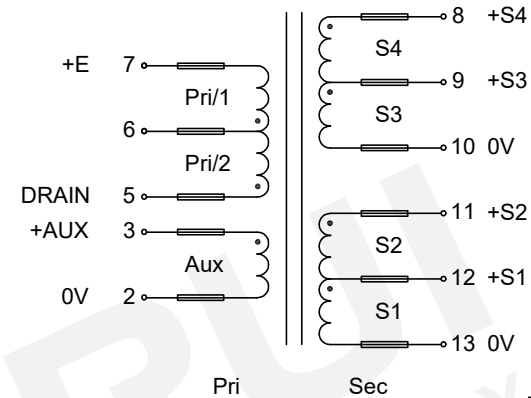

"." Dotted terminal
— White teflon tube

Winding Construction:

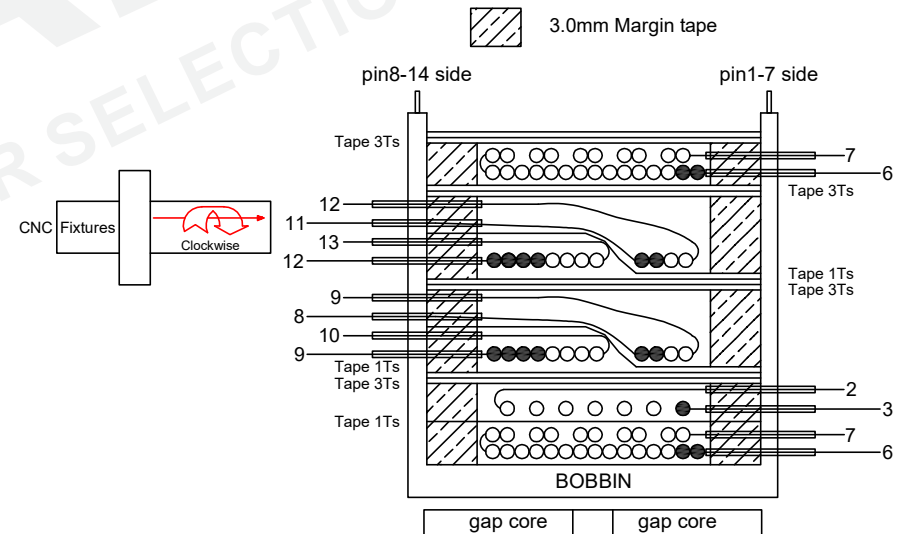

Electrical Characteristics

Inductance : L5-7= 500uH ±10%,at 1KHz,0.3V.

D.C.Resistance : 3-2= 30.0 mohms Max.

5-7= 130 mohms Max.

8-9= 15.0 mohms Max.

9-10= 5.50 mohms Max.

11-12= 15.0 mohms Max.

12-13= 5.50 mohms Max.

Turns Ratio : Pri/1:Aux:S1:S2:S3:S4:Pri/2=18:4:2:3:2:3:18±2%,at 20KHz,1V.

Hipot : Pri-Sec : 4000VAC/5mA/2S.

REV	DESCRIPTION	APPD	DATE	Tianchang Fuan Electronic Co Ltd www.fuantronics.net TEL: +86-550-7814888 FAX: +86-550-7831133	 Tolerances unless otherwise specified: (.X)±0.50 (XX)±0.25 Unit of measurement: mm	Make: Qiumei.Liu Checked: Beson. zhan Approved: Anson. zhan	DRAWING TITLE ETD34 FLYBACK TRANSFORMER Material Number: A2174050S000	Customer P/N: Document/Rev: 00 Specification Sheet: 1 of 3 Date of Recognition: Jan./02/2020
-----	-------------	------	------	---------------------------------------------------------------------------------------------------------	----------------------------------------------------------------------------------------------	-------------------------------------------------------------------	------------------------------------------------------------------------------------	-------------------------------------------------------------------------------------------------------

P/N: FAT74050

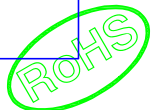

Winding step:

Winding	Terminal		Wire Gauge	Turns	Tape	Margin tape		Tube		Remarks
	start	end				top side	pins side	start	end	
Pri/1	6	7	0.50mm*2P 2UEW-F	18	1	3.0mm	3.0mm	YES	YES	Clockwise close+space coil
Aux	3	2	0.50mm*1P 2UEW-F	4	3	3.0mm	3.0mm	YES	YES	Clockwise space coil
S1	9	10	0.50mm*4P 2UEW-F	2	1	3.0mm	3.0mm	YES	YES	Clockwise close coil(pin8-14 side)
S2	8	9	0.50mm*2P 2UEW-F	3	3	3.0mm	3.0mm	YES	YES	Clockwise close coil(pin1-7 side)
S3	12	13	0.50mm*4P 2UEW-F	2	1	3.0mm	3.0mm	YES	YES	Clockwise close coil(pin8-14 side)
S4	11	12	0.50mm*2P 2UEW-F	3	3	3.0mm	3.0mm	YES	YES	Clockwise close coil(pin1-7 side)
Pri/2	5	6	0.50mm*2P 2UEW-F	18	3	3.0mm	3.0mm	YES	YES	Clockwise close+space coil

General Properties:

Operating Temperature:-40°C to +105°C.
 Storage Temperature:-25°C to +85°C.
 Insulation Class:B.

Label:

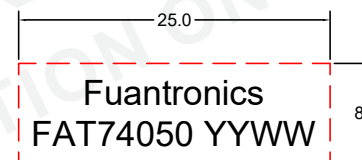

yy ww
 year cycle

Wave Soldering

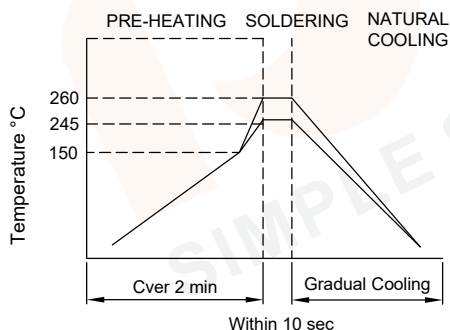

Note:
 1.Never Contact the ceramic with the iron tip;
 2.1.0mm tip diameter(max).

Remark:

- 1.Use Laser printing;
- 2.Clear writing and legibility, not easy to erase;
- 3.Border here means size range, not be printed;
- 4.Font:Arial;Height:2.00mm.

				Tianchang Fuan Electronic Co Ltd www.fuantronics.net TEL: +86-550-7814888 FAX: +86-550-7831133	Tolerances unless otherwise specified: (.X)±0.50 (XX)±0.25 Unit of measurement: mm	Make: Qiumei.Liu Checked: Beson. zhan Approved: Anson. zhan	DRAWING TITLE ETD34 FLYBACK TRANSFORMER Material Number: A2174050S000	Customer P/N: Document/Rev: 00 Specification Sheet: 2 of 3 Date of Recognition: Jan./02/2020
REV	DESCRIPTION	APPD	DATE					

P/N: FAT74050

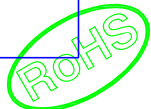

List of UL Certificate:

No.	Part Name	Mat'l Description	Supplier	UL Number
1	Bobbin	ETD-3401/T385J/FAY01091	Chang Chun Plastics Co Ltd	E59481
2	Copper wire	2UEW-F/155C	Dong Guan YiDa Industrial Co Ltd	E344055
		2UEW-F/155C	Elektrisola Hangzhou Co Ltd	E258243
3	Core	ETD34/34/11 HPP4	Anhui Hualin Magnetic Technology Go Ltd	N/A
		ETD34/34/11 TP4	TDG	N/A
4	Tape	JY25-A(b)/130C(Faint Yellow)	Jingjiang Jingyi Adhesive Product Co Ltd	E246950
		CT (b)(g)/130C(Faint Yellow)	JingJiang Yahua Pressure Sensitive Glue Co Ltd	E165111
5	Margin tape	WF310(a)/130C	Jingjiang Jingyi Adhesive Product Co Ltd	E246950
		WF* (c)(h)/130C	JingJiang Yahua Pressure Sensitive Glue Co Ltd	E165111
6	Tube	CB-TT-L/200°C	ChangYuan Electronics Group Co Ltd	E180908
		CB-TFL/200°C	Dongguan City Changjie Metals & Plastic Products Co Ltd	E338209
7	Epoxy	E-500	Dongguan Eatto Electronic Material Co Ltd	E218090
8	Varnish	T-4260(a)/MW80-C	SuZhou TaiHu Electric Advanced Material Co Ltd	E228349

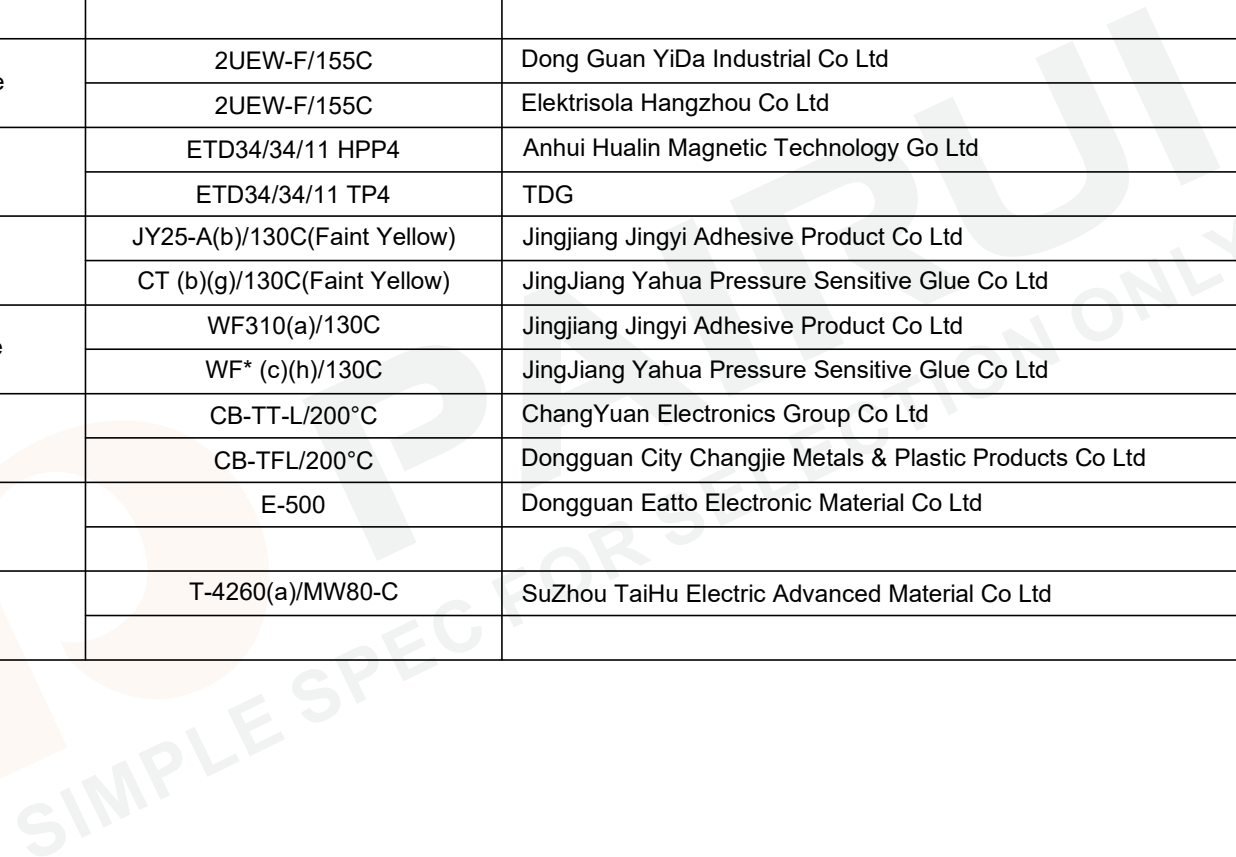

				Tianchang Fuan Electronic Co Ltd www.fuantronics.net TEL: +86-550-7814888 FAX: +86-550-7831133	Tolerances unless otherwise specified: (.X)±0.50 (XX)±0.25 Unit of measurement: mm	Make: Qiumei.Liu Checked: Beson. zhan Approved: Anson. zhan	DRAWING TITLE ETD34 FLYBACK TRANSFORMER Material Number: A2174050S000	Customer P/N: Document/Rev: 00 Specification Sheet: 3 of 3 Date of Recognition: Jan./02/2020
REV	DESCRIPTION	APPD	DATE					